

JB SANITARY

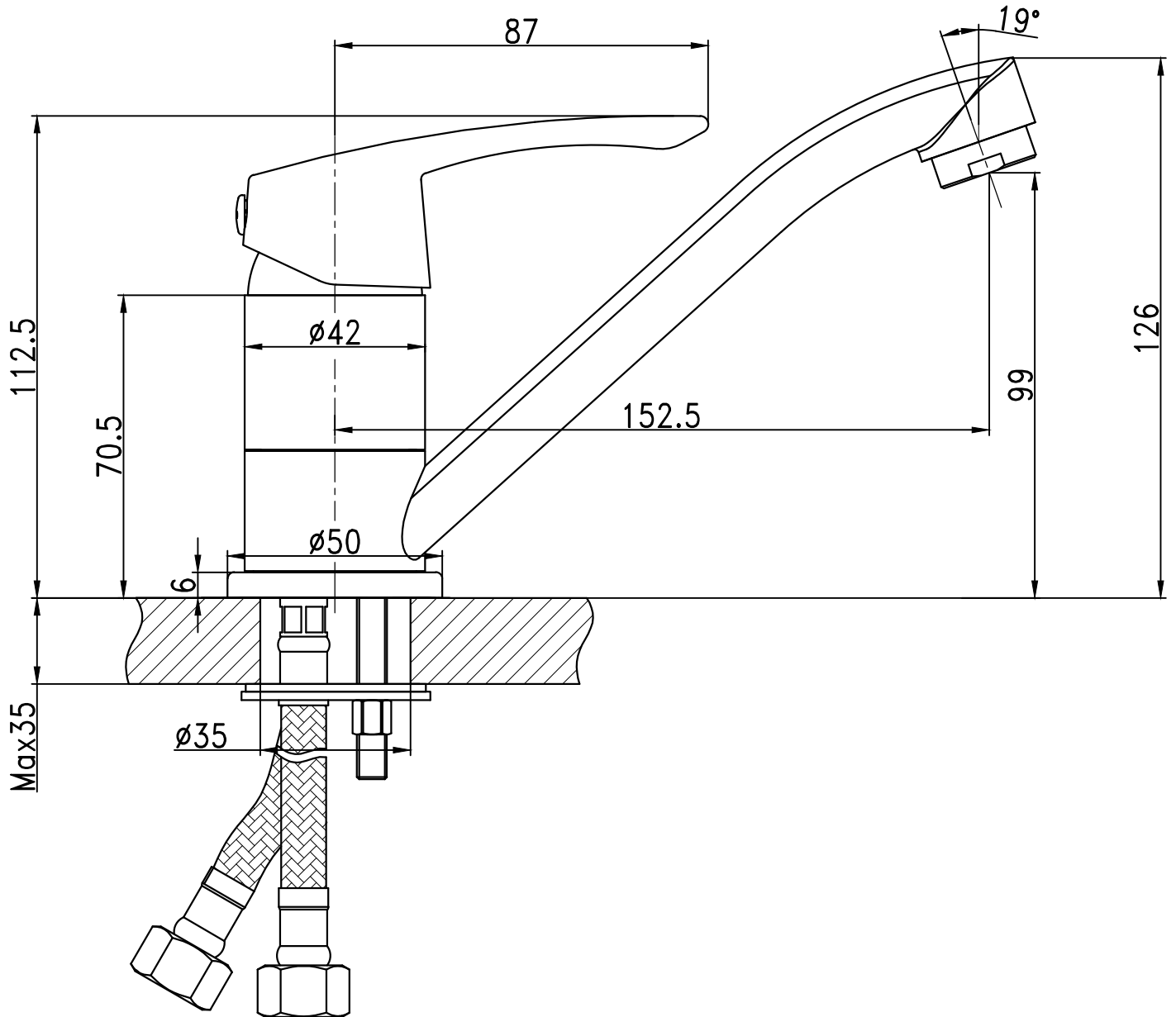

L10 20 00